

11 Series Electrified & Fire Series Door Cords

IPIXA Security 11 Series electrified & Fire series is developed to support the need for security applications for doors used for fire escape routes & for those doors which would require electrified door locks & associated accessories

The aesthetics and functionality improves while using electrified locks and accessories compared to standard access control hardware 11 Series is developed keeping the designers choice in mind



EFS1112

Product Specifications

Material	Stainless Steel
Door Cord Type	Exposed
Size	410mm (Length) , 13 mm (Width) Diameter
Usage	Simplest and most economical solution for power transfer
Cable Thickness Supported	Supports interior wire cable upto 0.5 inch or 12 mm

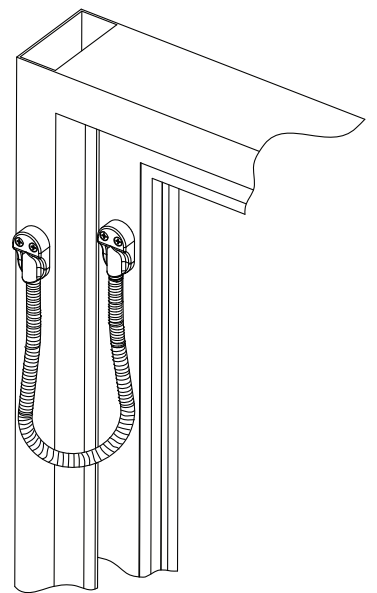
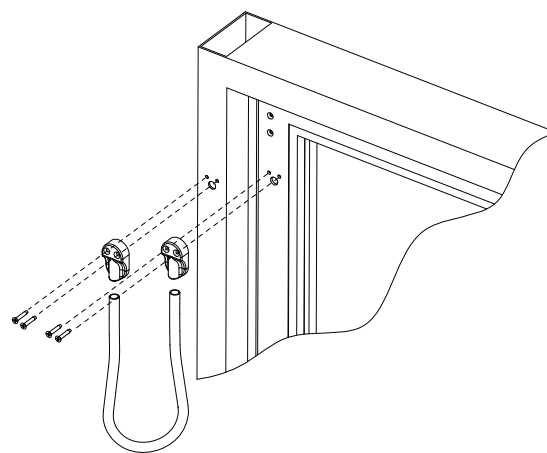
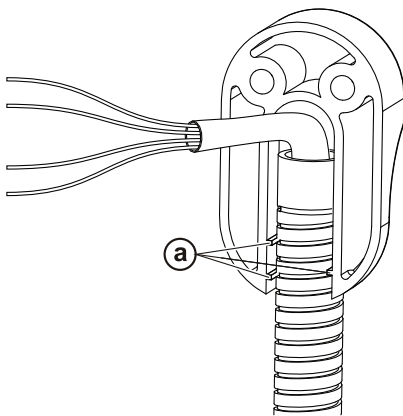

IPIXA SECURITY LIMITED
Kemp House, 160 City Road,
London, EC1V 2NX,
United Kingdom
ipixa.co.uk